

MSME, SSI, CE
AN ISO : 13485:2016
CERTIFIED COMPANY

Gynecology

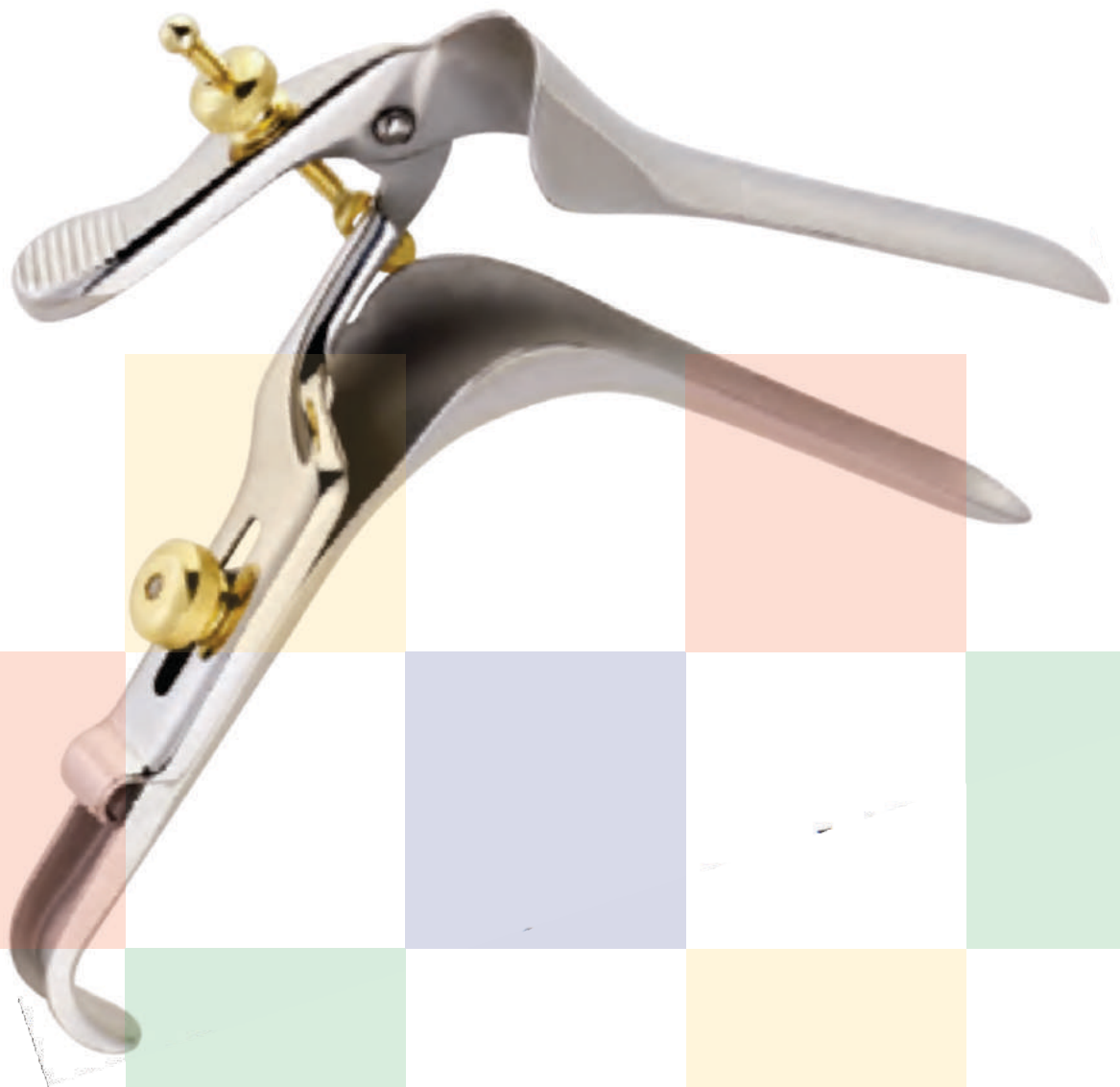

Vaginal Specula and Retractors

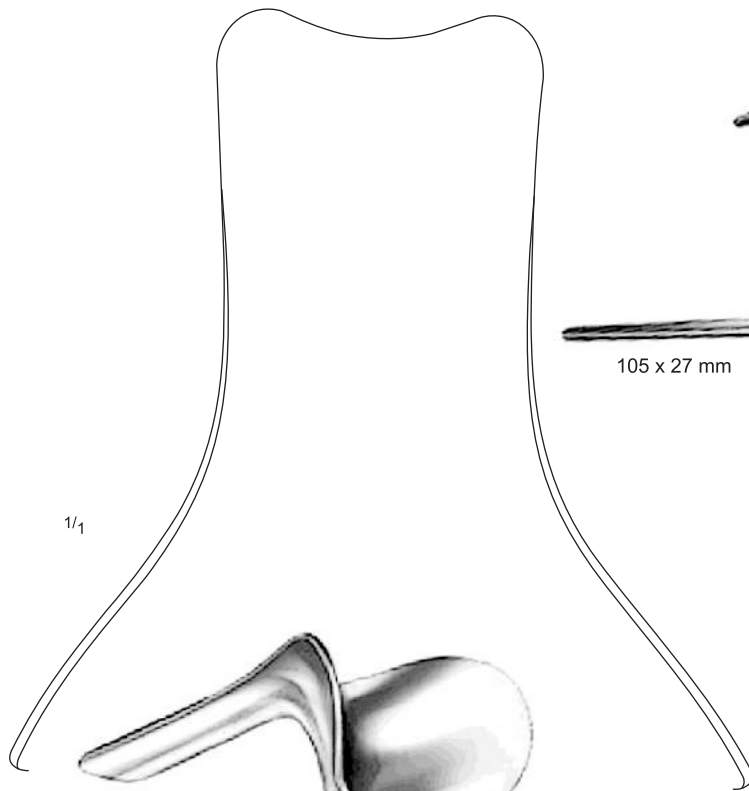

Complete with
removable weight

1/2

AUVARD
10-001-240
24 cm / 9 1/2"

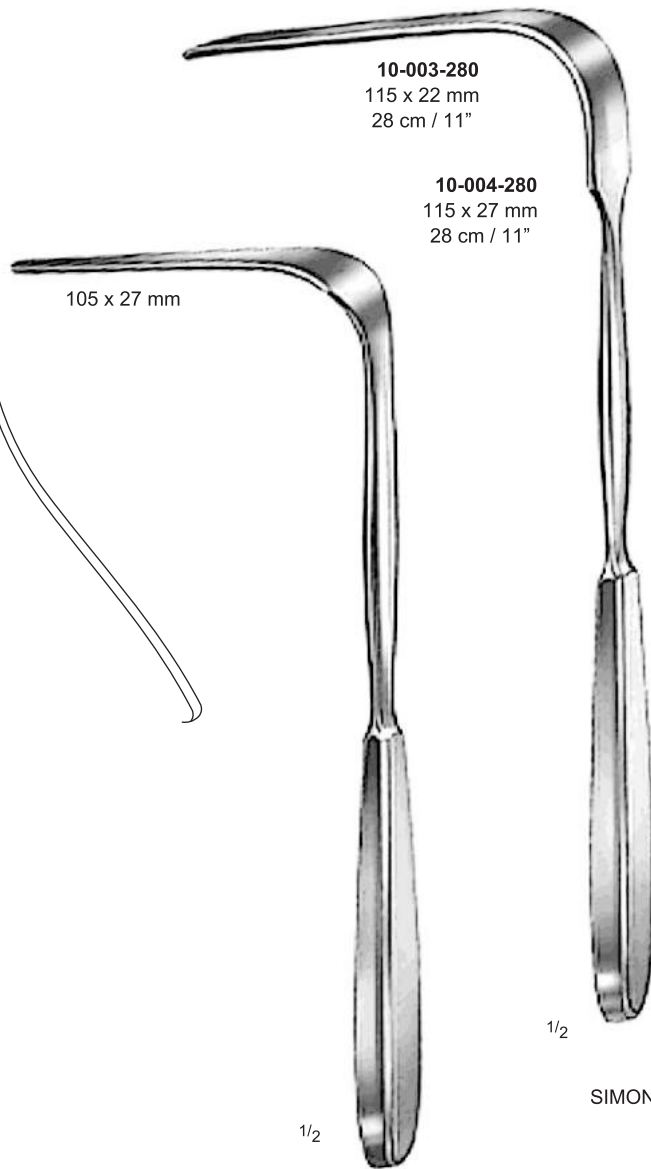

1/2

MARTIN
10-002-250
25 cm / 10"

1/2

SIMON

Vaginal Specula and Retractors

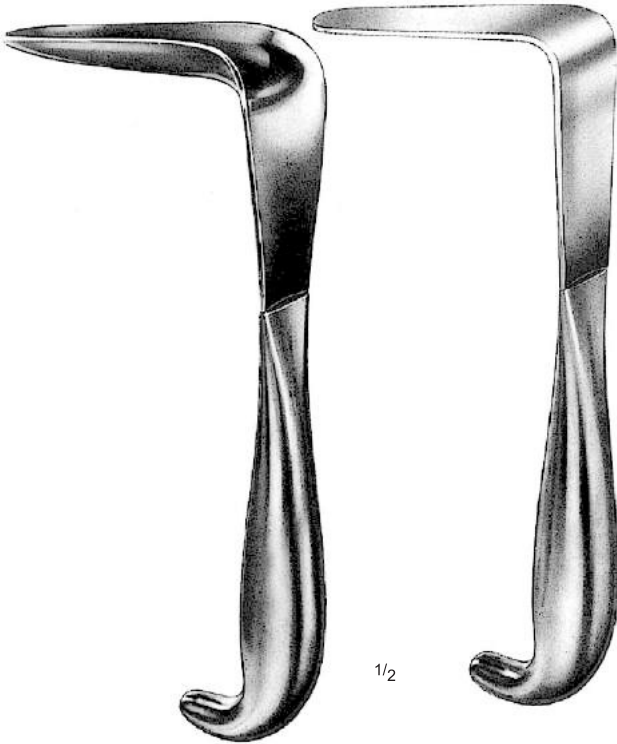

MATHIEU
 10-005-095 – 95 x 16 - 26 mm
 10-006-095 – 95 x 16 - 30 mm
 Vaginal Specula

MATHIEU
 10-007-100 – 100 x 11 - 20 mm
 10-008-100 – 100 x 14 - 26 mm
 Vaginal Retractor



KRISTELLER
 Set of one Speculum
 and one Retractor
 10-010-001 – Fig. 1
 10-010-002 – Fig. 2
 10-010-003 – Fig. 3

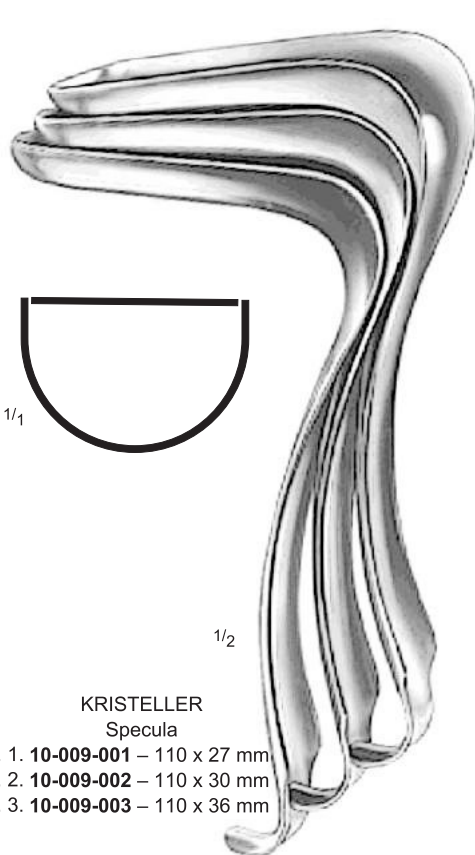

KRISTELLER
 Specula
 Fig. 1. 10-009-001 – 110 x 27 mm
 Fig. 2. 10-009-002 – 110 x 30 mm
 Fig. 3. 10-009-003 – 110 x 36 mm

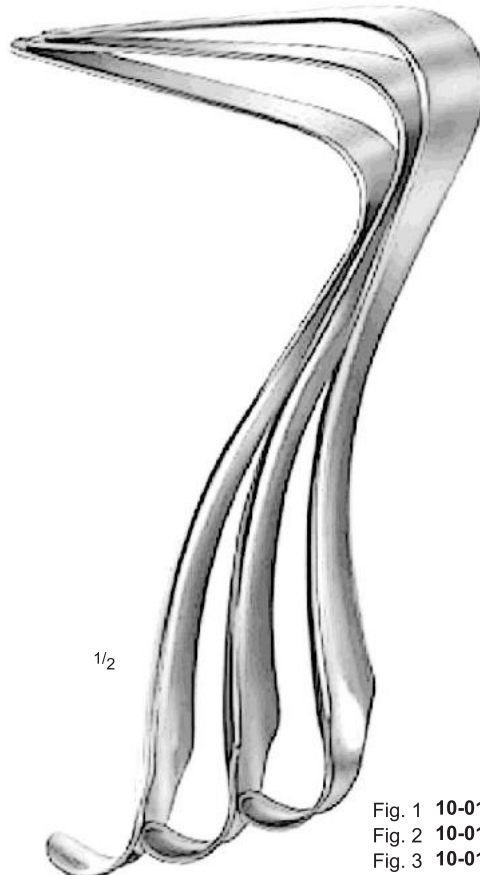

KRISTELLER
 Retractors
 Fig. 1. 10-011-001 – 115 x 23 mm
 Fig. 2. 10-011-002 – 115 x 26 mm
 Fig. 3. 10-011-003 – 115 x 32 mm

Vaginal Specula and Retractors

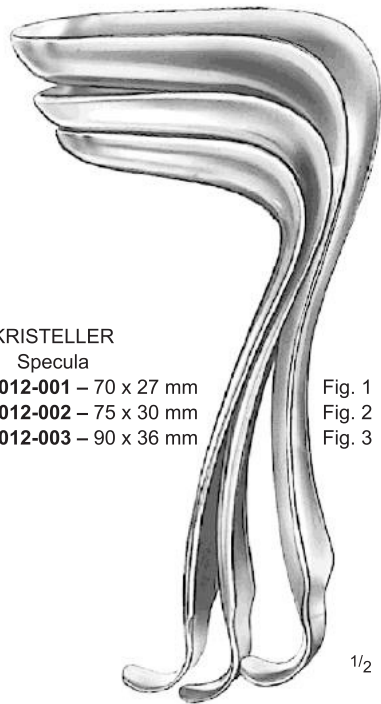

KRISTELLER
Specula

- Fig. 1 **10-012-001** – 70 x 27 mm
- Fig. 2 **10-012-002** – 75 x 30 mm
- Fig. 3 **10-012-003** – 90 x 36 mm

1/2

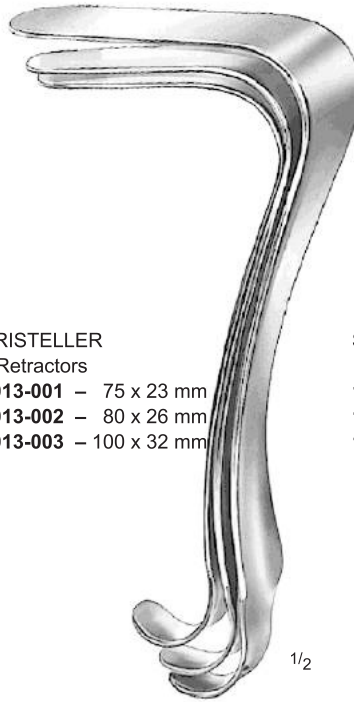

KRISTELLER
Retractors

- Fig. 1 **10-013-001** – 75 x 23 mm
- Fig. 2 **10-013-002** – 80 x 26 mm
- Fig. 3 **10-013-003** – 100 x 32 mm

1/2



KRISTELLER
Set of 1 Speculum and
1 Retractor each

- 10-014-001** – Fig. 1
- 10-014-002** – Fig. 2
- 10-014-003** – Fig. 3

1/2

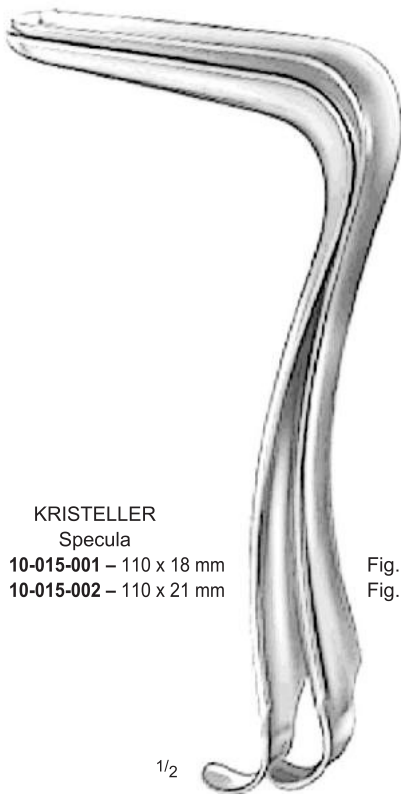

KRISTELLER
Specula

- Fig. 1 **10-015-001** – 110 x 18 mm
- Fig. 2 **10-015-002** – 110 x 21 mm

1/2

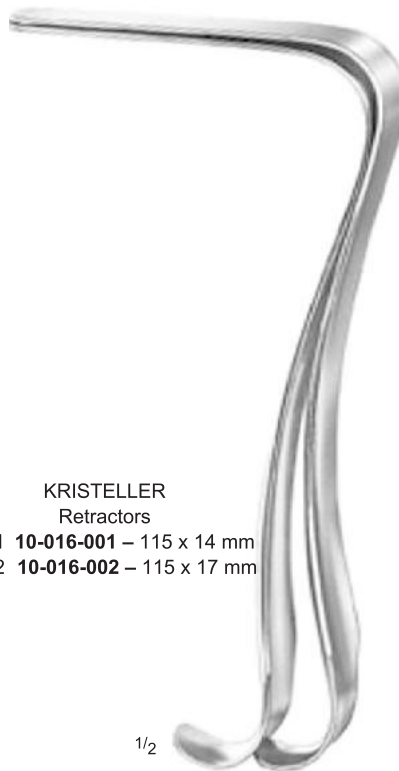

KRISTELLER
Retractors

- Fig. 1 **10-016-001** – 115 x 14 mm
- Fig. 2 **10-016-002** – 115 x 17 mm

1/2

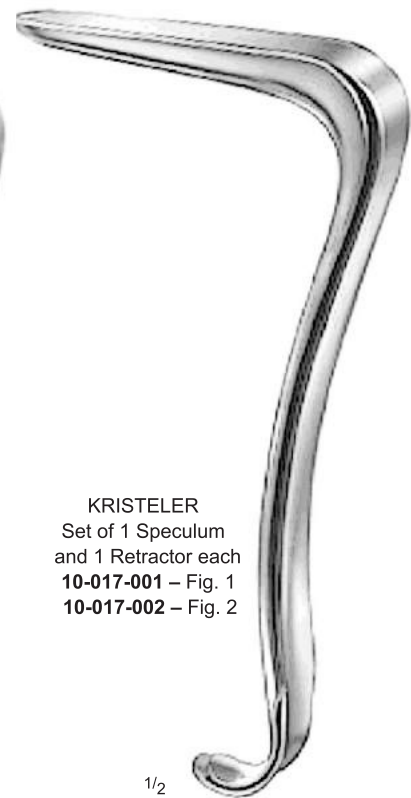

KRISTELLER
Set of 1 Speculum
and 1 Retractor each

- 10-017-001** – Fig. 1
- 10-017-002** – Fig. 2

1/2

Vaginal Specula and Retractors



SIMS
10-018-001 – Fig. 1 70 x 25 mm
75 x 30 mm
10-018-002 – Fig. 2 75 x 30 mm
80 x 35 mm
10-018-003 – Fig. 3 80 x 35 mm
90 x 40 mm

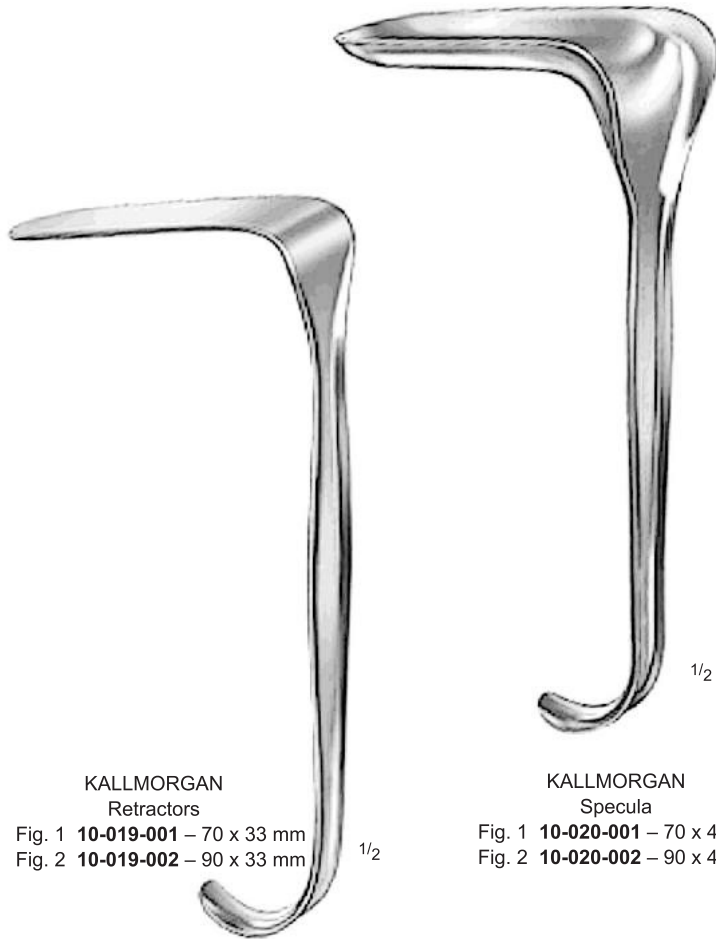

KALLMORGAN
Retractors
Fig. 1 10-019-001 – 70 x 33 mm
Fig. 2 10-019-002 – 90 x 33 mm

KALLMORGAN
Specula
Fig. 1 10-020-001 – 70 x 40 mm
Fig. 2 10-020-002 – 90 x 40 mm

KALLMORGAN
Set of 1 Speculum and Retractor each
Fig. 1 10-021-001
Fig. 2 10-021-002

Vaginal Specula and Retractors



COLLIN

- 10-022-090 – 90 x 25 mm
- 10-023-090 – 90 x 29 mm
- 10-024-100 – 100 x 35 mm
- 10-025-100 – 100 x 40 mm
- 10-026-110 – 110 x 36 mm
- 10-027-110 – 110 x 40 mm

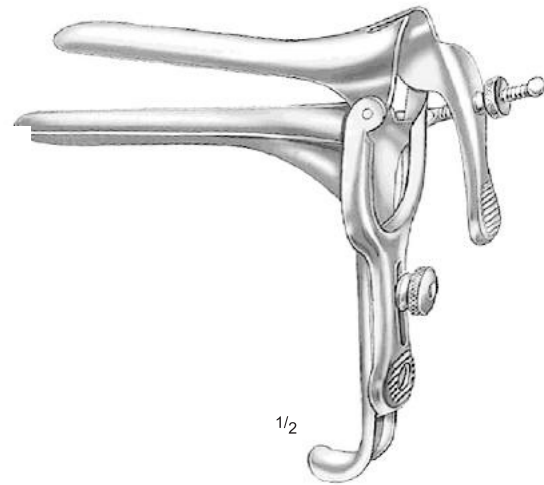

PEDERSON

- 10-028-076 – 76 x 13 mm
- 10-029-100 – 100 x 22 mm
- 10-030-120 – 120 x 25 mm



60 x 30 mm

- 10-034-000 – 100 x 20 mm
- 10-035-000 – 100 x 25 mm
- 10-036-000 – 100 x 30 mm
- 10-037-000 – 100 x 35 mm
- 10-038-000 – 100 x 40 mm
- 10-039-000 – 130 x 20 mm
- 10-040-000 – 130 x 25 mm
- 10-041-000 – 130 x 30 mm
- 10-042-000 – 130 x 35 mm
- 10-043-000 – 130 x 40 mm

BRIESKY

27 - 30 cm / 10 ³/₄" – 11 ³/₄"

1/3

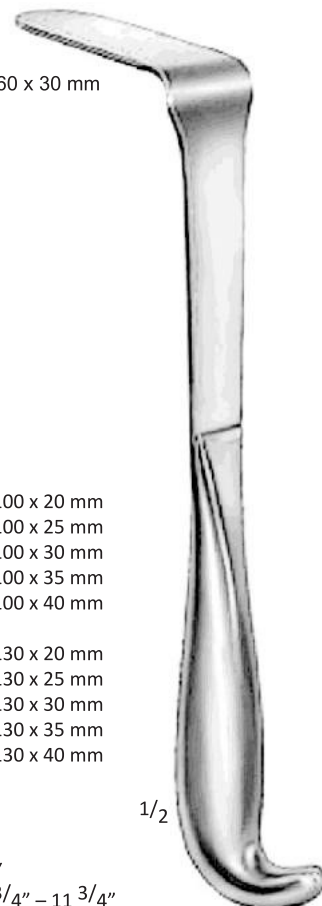

1/2

DOYEN
 10-044-230
 23 cm / 9"



GRAVES

- 10-031-075 – 75 x 20 mm
- 10-032-100 – 100 x 30 mm
- 10-033-150 – 115 x 35 mm

1/2

Vaginal Specula

Central Fixation Screw

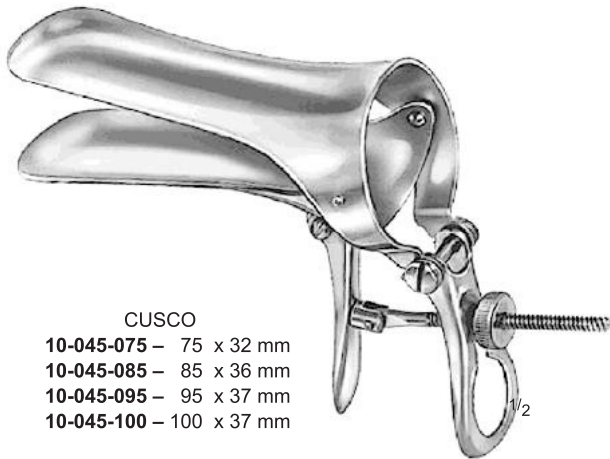

- CUSCO
 10-045-075 – 75 x 32 mm
 10-045-085 – 85 x 36 mm
 10-045-095 – 95 x 37 mm
 10-045-100 – 100 x 37 mm

For Virgins

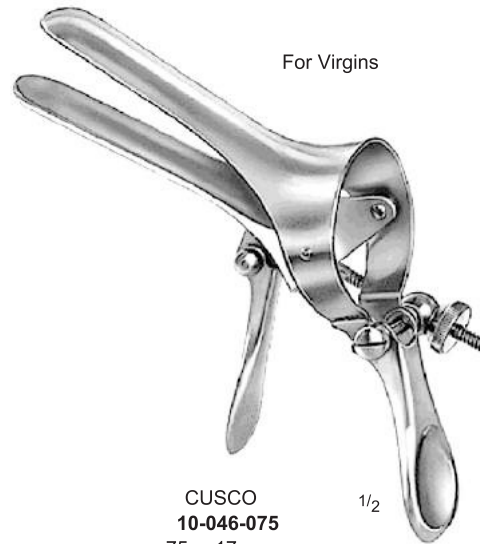

- CUSCO
 10-046-075
 75 x 17 mm

Swiss Pattern

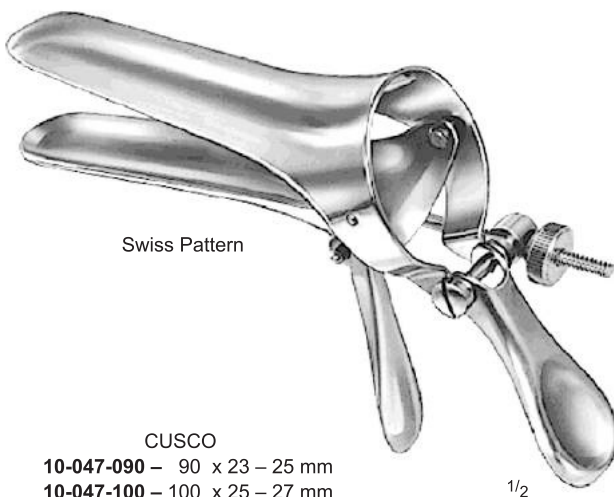

- CUSCO
 10-047-090 – 90 x 23 – 25 mm
 10-047-100 – 100 x 25 – 27 mm
 10-047-110 – 110 x 27 – 30 mm

Lateral Fixation Screw

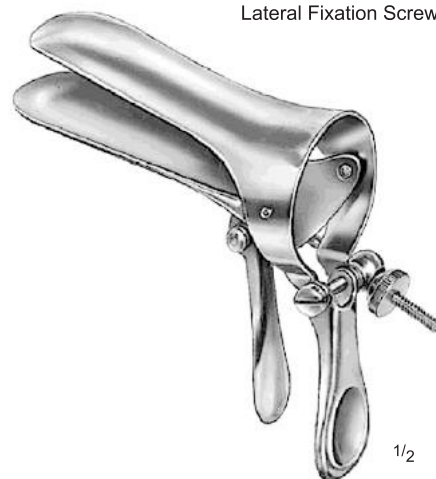

- CUSCO
 10-048-075 – 75 x 32 mm
 10-048-085 – 85 x 36 mm
 10-048-095 – 95 x 37 mm
 10-048-100 – 100 x 35 mm

Uterine Dilators

With Sloped Handle

mm Ø

1	10-049-001	
1.5		10-049-015
2	10-049-002	
2.5		10-049-025
3	10-049-003	
3.5		10-049-35
4	10-049-004	
4.5		10-049-045
5	10-049-005	
5.5		10-049-055
6	10-049-006	
6.5		10-049-065
7	10-049-007	
7.5		10-049-075
8	10-049-008	
8.5		10-049-085
9	10-049-009	
9.5		10-049-095
10	10-049-010	
10.5		10-049-105
11	10-049-011	
11.5		10-049-115
12	10-049-012	
12.5		10-049-125
13	10-049-013	
13.5		10-049-135
14	10-049-014	
14.5		10-049-145
15	10-049-015	



HEGAR

Uterine Dilators



mmø

1 + 2 mm	10-050-001
3 + 4 mm	10-050-003
5 + 6 mm	10-050-005
7 + 8 mm	10-050-007
9 + 10 mm	10-050-009
11 + 12 mm	10-050-011
13 + 14 mm	10-050-013
15 + 16 mm	10-050-015
17 + 18 mm	10-050-017
19 + 20 mm	10-050-020
21 + 22 mm	10-050-022
23 + 24 mm	10-050-024
25 + 26 mm	10-050-026

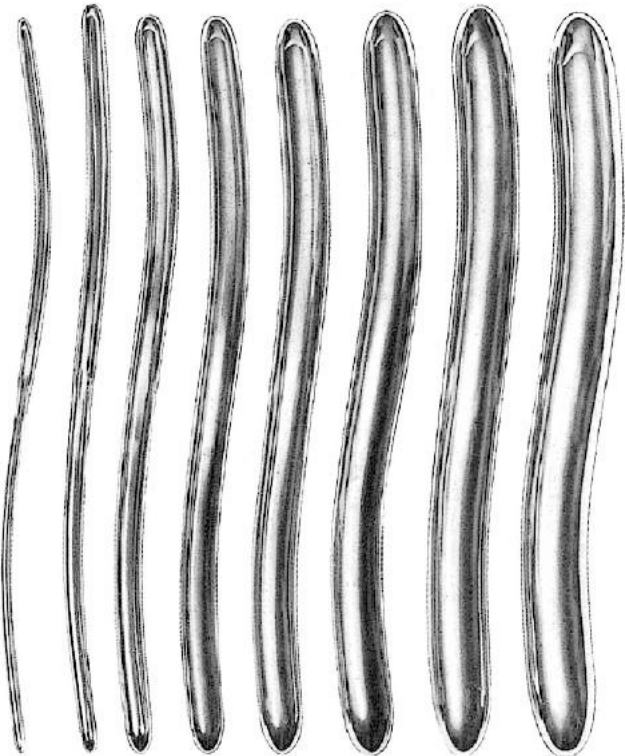

HEGAR

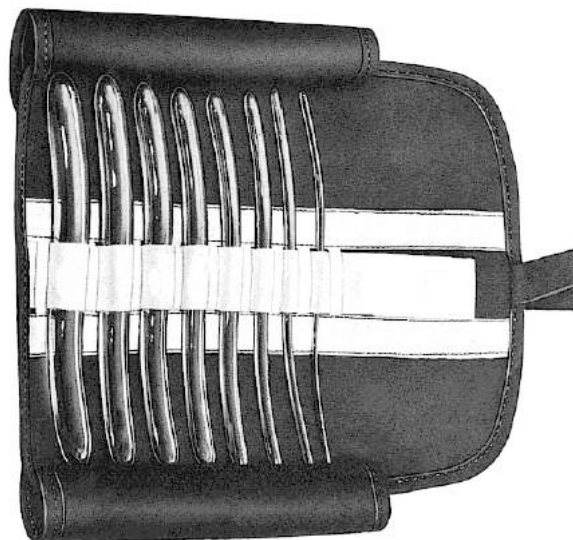

10-051-000

Set of 8 dilators, 3 + 4mm – 17 + 18 mm,
in canvas roll.

Uterine Dilators



1/2

HANK

ø mm

- 10-052-009 – Fig. 9/10 = 4.5 / 5 mm
- 10-052-011 – Fig. 11/12 = 5.5 / 6 mm
- 10-052-013 – Fig. 13/14 = 6.5 / 7 mm
- 10-052-015 – Fig. 15/16 = 7.5 / 8 mm
- 10-052-017 – Fig. 17/18 = 8.5 / 9 mm
- 10-052-019 – Fig. 19/20 = 9.5 / 10 mm

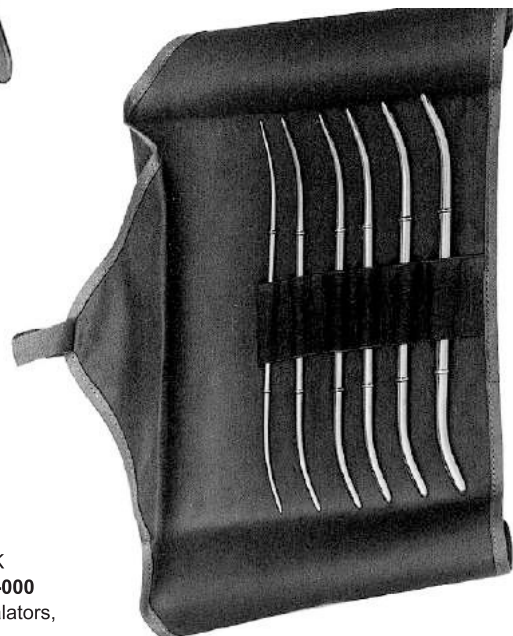

HANK
10-053-000
Set of 6 Dilators,

Endocervical Specula, Uterine Sounds, Depressors

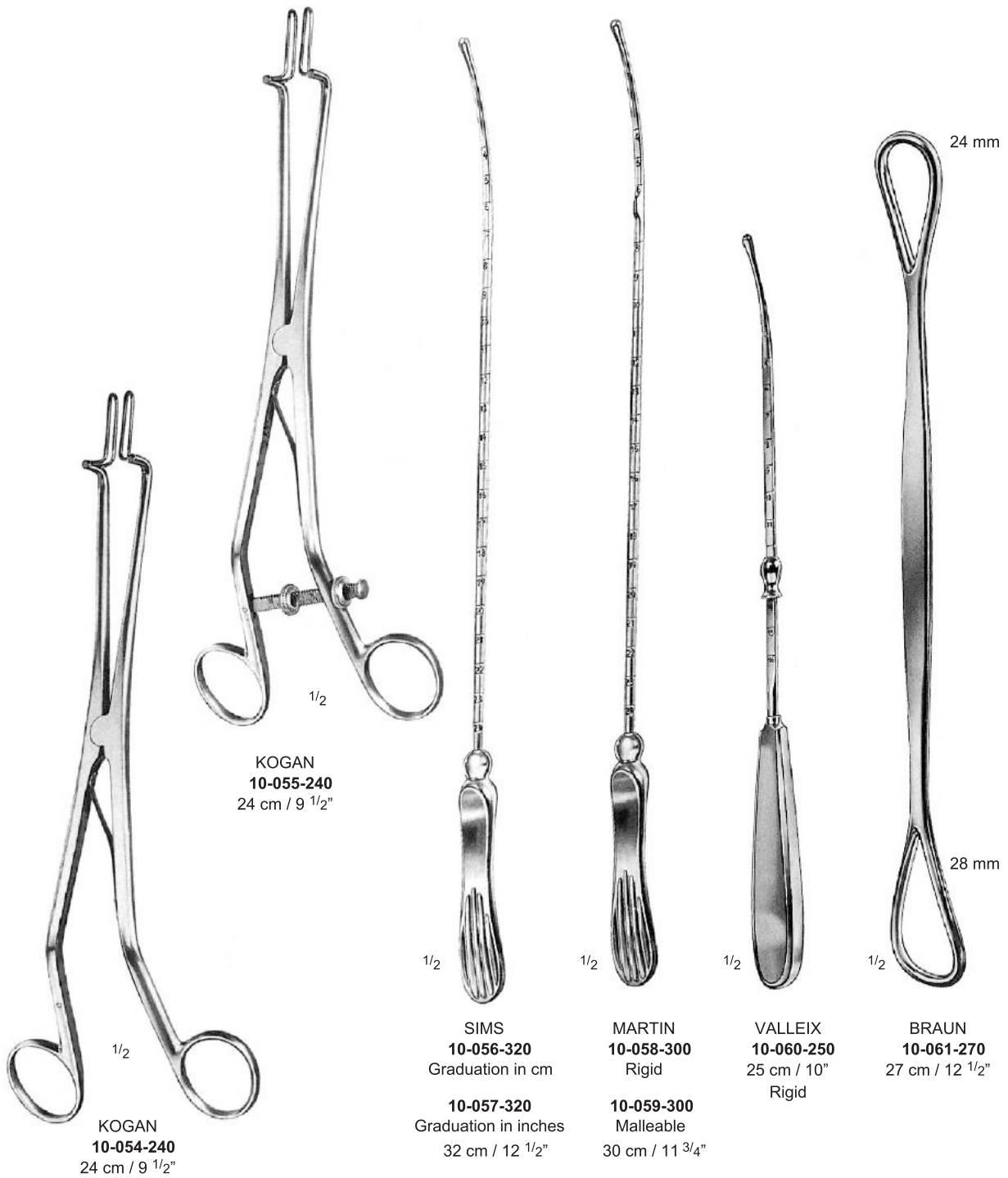

Tenaculum Forceps

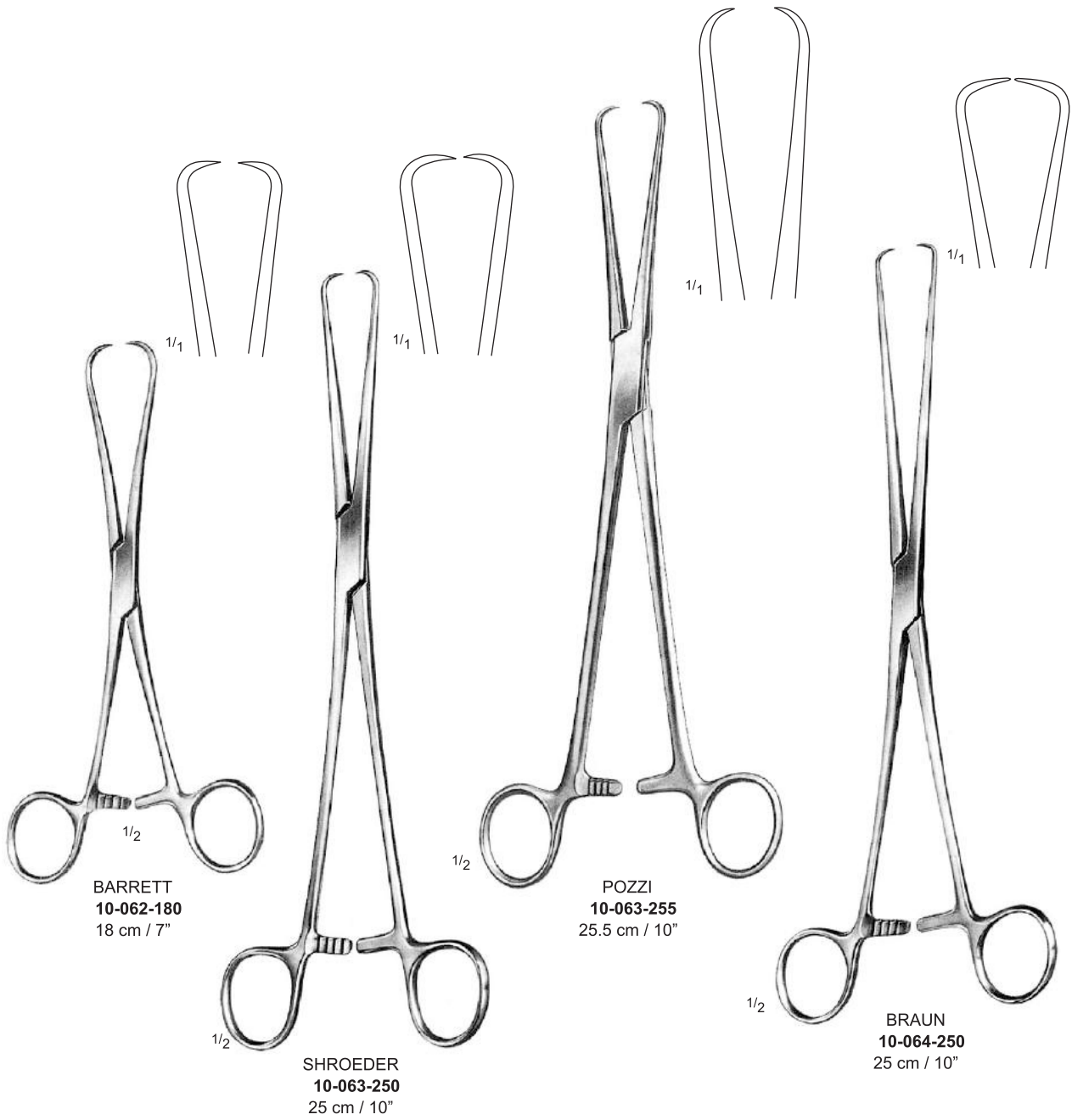

Tenaculum Forceps

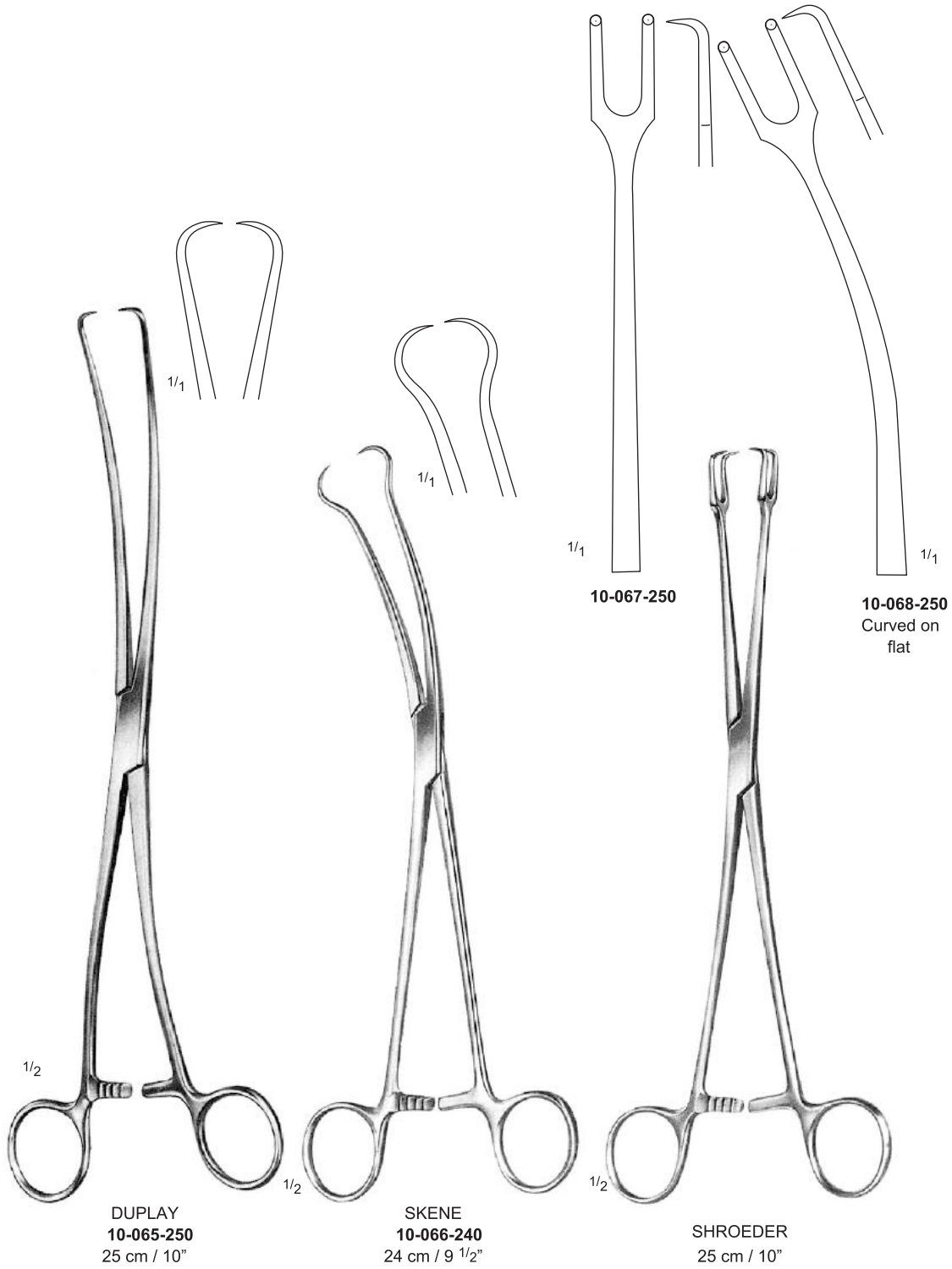

Vulsellum Forceps

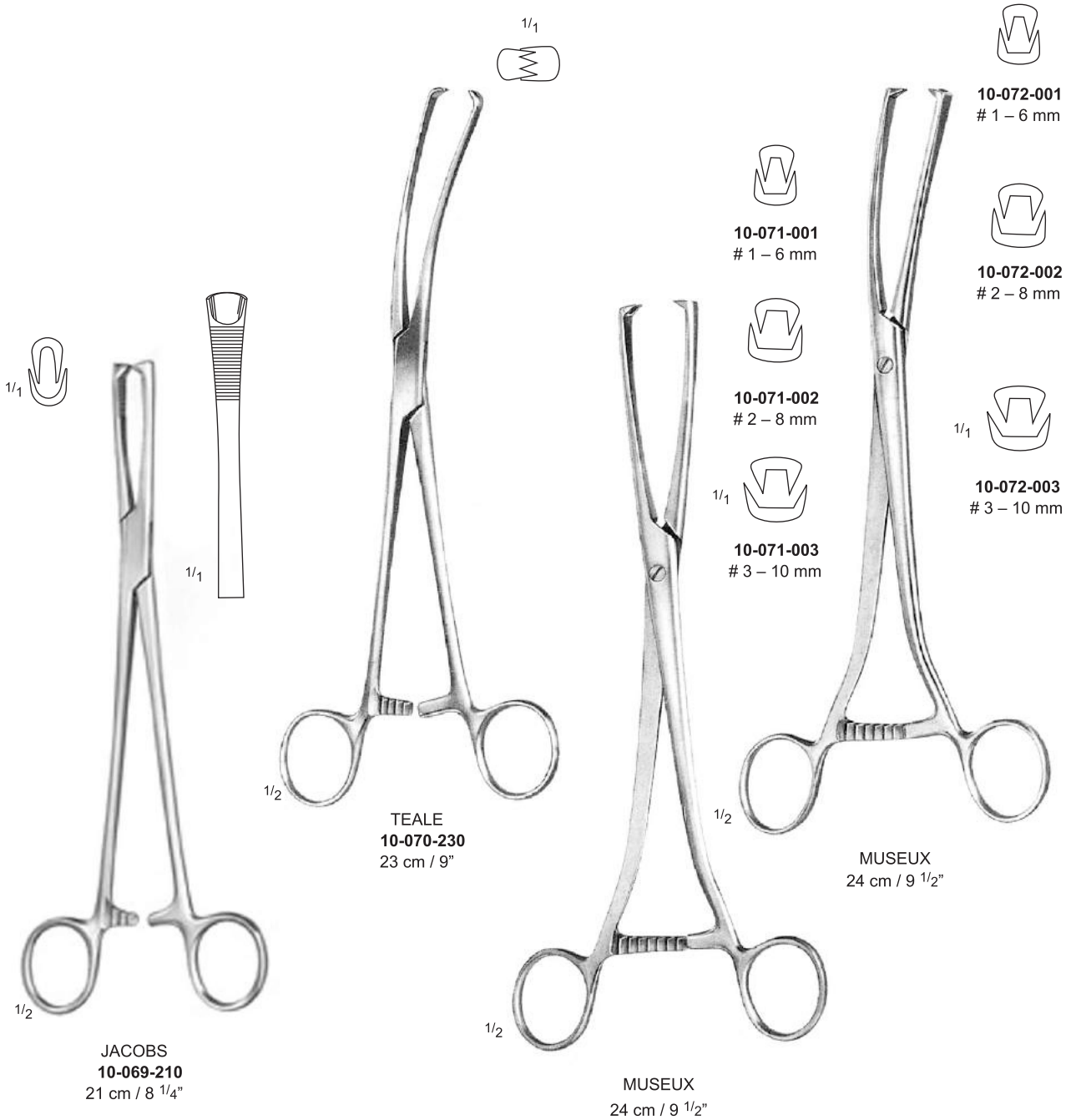

Ovary and Polypus Seizing Forceps



DOYEN
10-073-200
20 cm / 8"

NOTO
10-074-270
27 cm / 10 ³/₄"

KELLY
10-075-320
32 cm / 12 ¹/₂"

Uterine Elevating Forceps

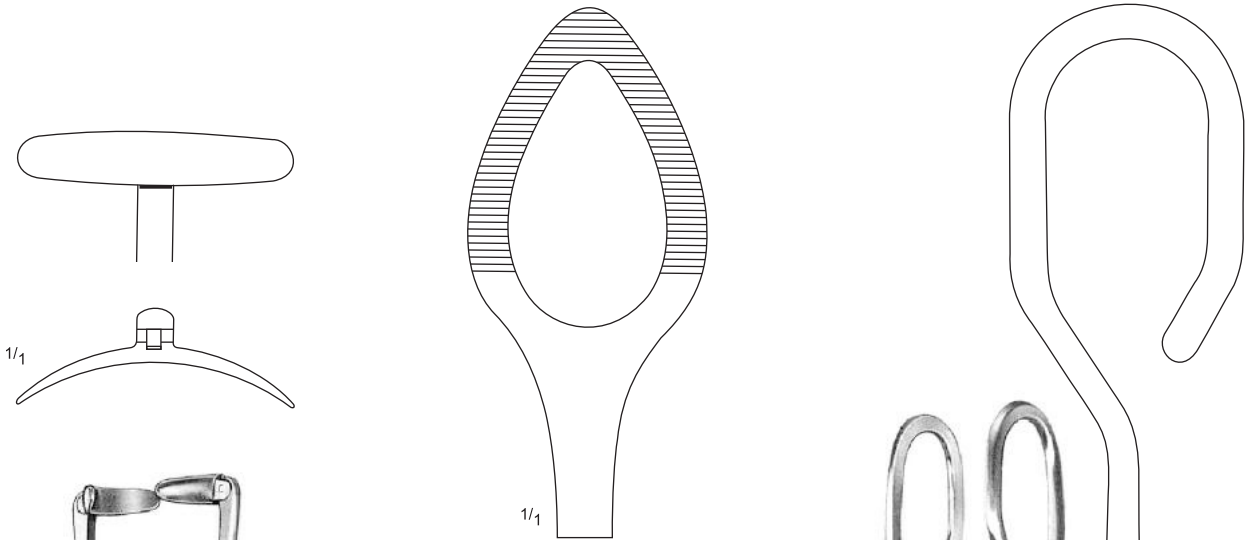

COLLIN
10-076-260
26 cm / 10 1/4"



SOMER
10-077-0240
24 cm / 9 1/2"

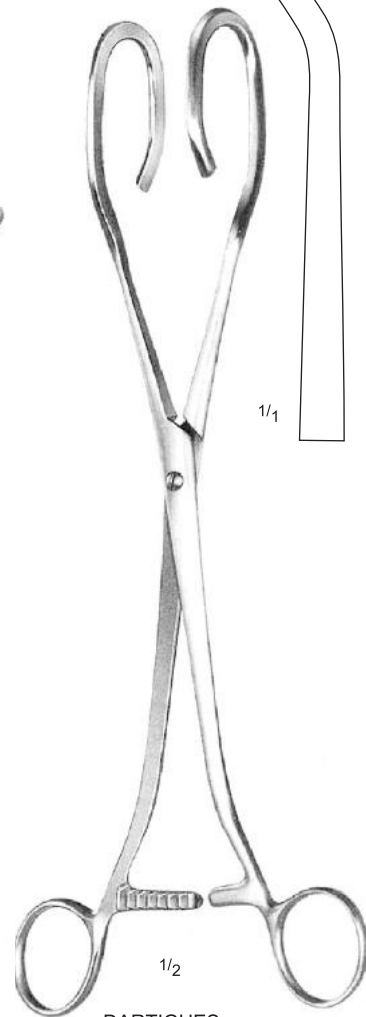

DARTIGUES
10-078-260
26 cm / 10 1/4"

Ovary and Polypus Seizing Forceps



DOYEN
10-079-200
20 cm / 8"

NOTO
10-080-270
27 cm / 10 3/4"

KELLY
10-081-320
32 cm / 12 1/2"

Cervical Biopsy Forceps



THOMS - GAYLOR
10-082-240
 24 cm / 9 1/2"

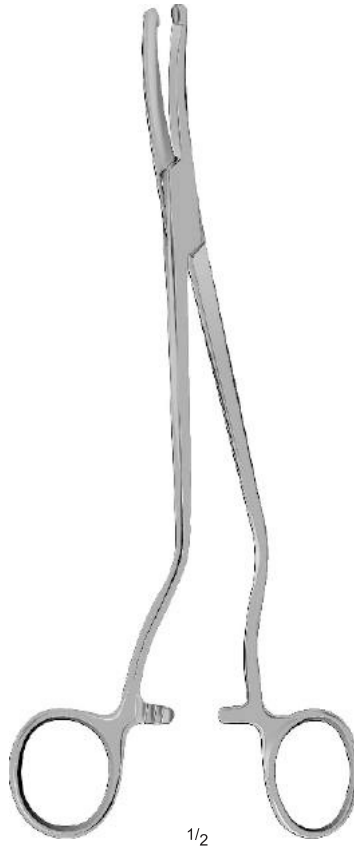

PROFESSOR MEDINA
10-083-220
 22 cm / 8 3/4"

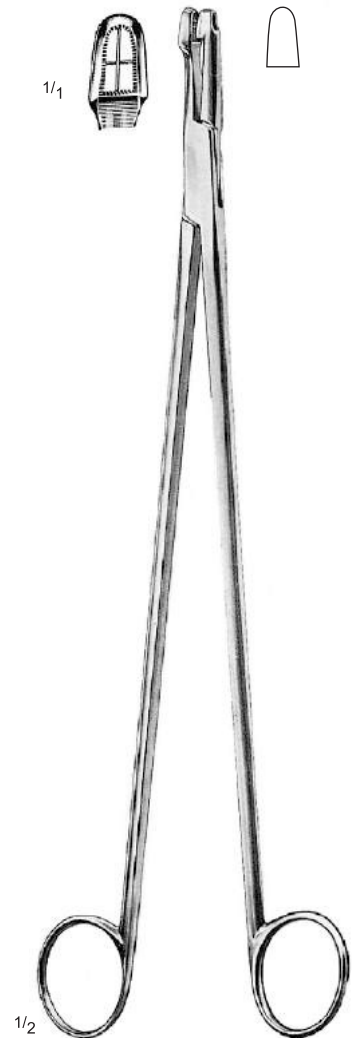

SCHUBERT
10-084-210
 21 cm / 8 1/4"

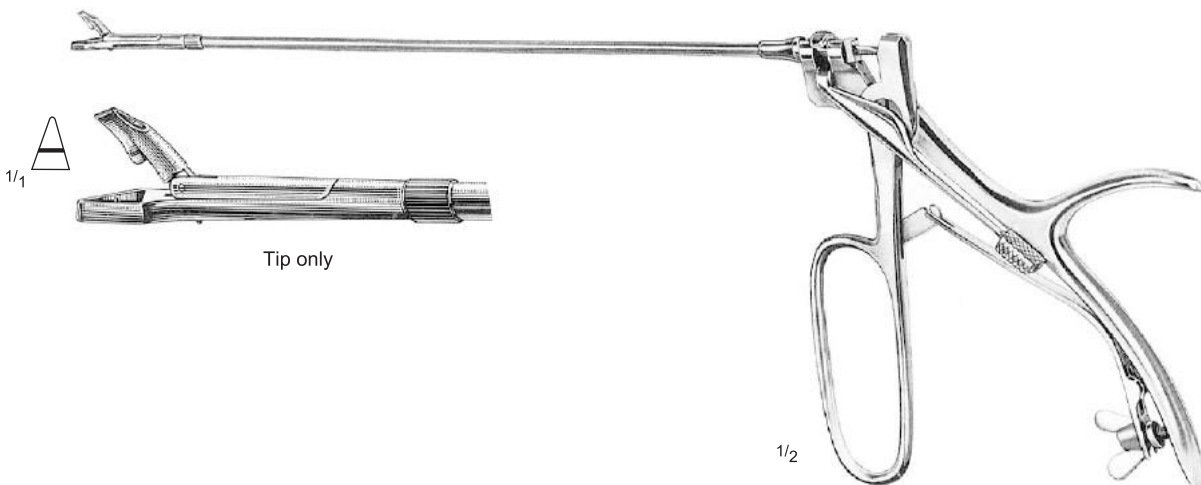

SCHUMACHER
10-085-000

Cervical Biopsy Forceps

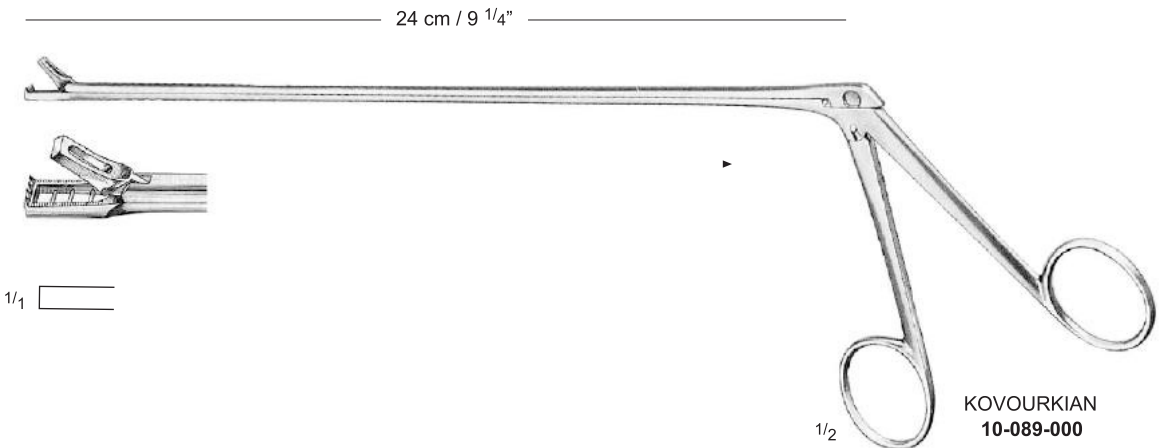
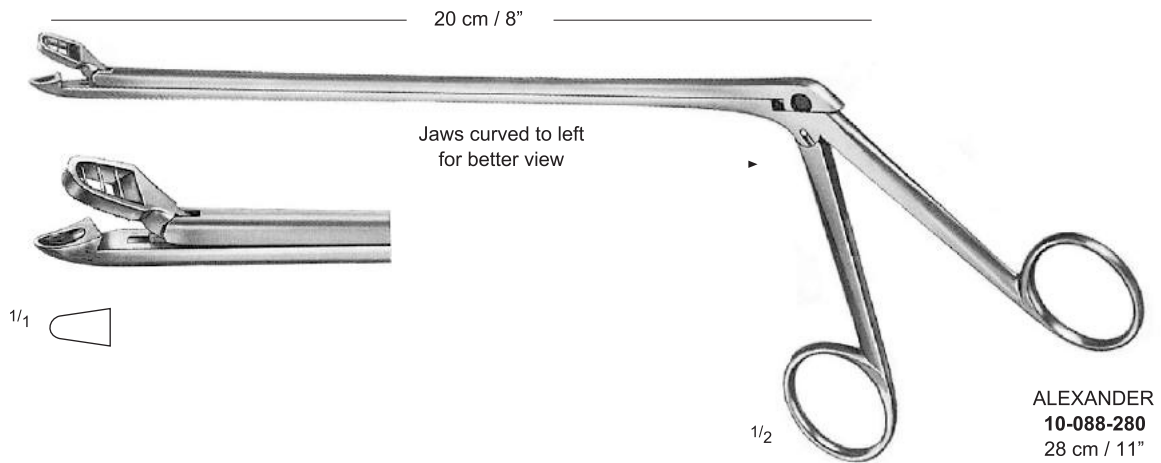
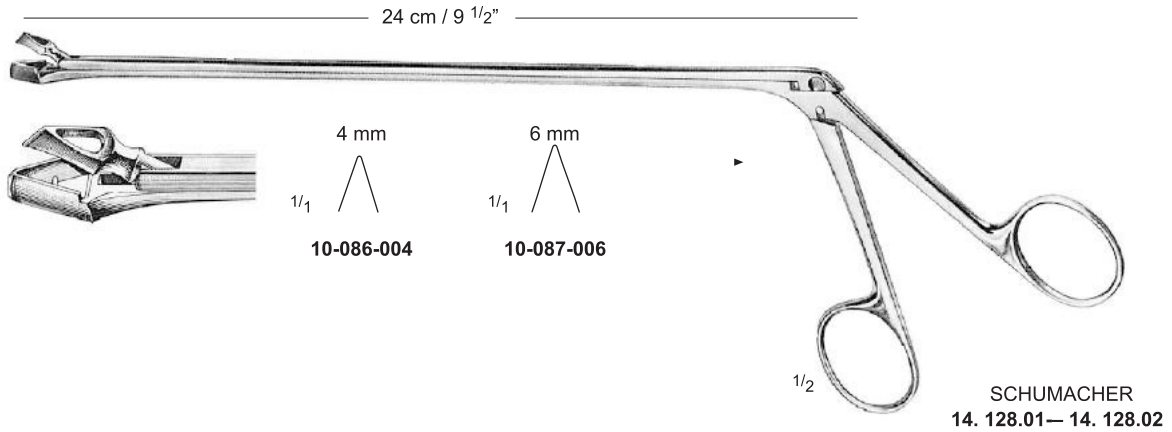

Myoma Screws, Suction Biopsy Curettes

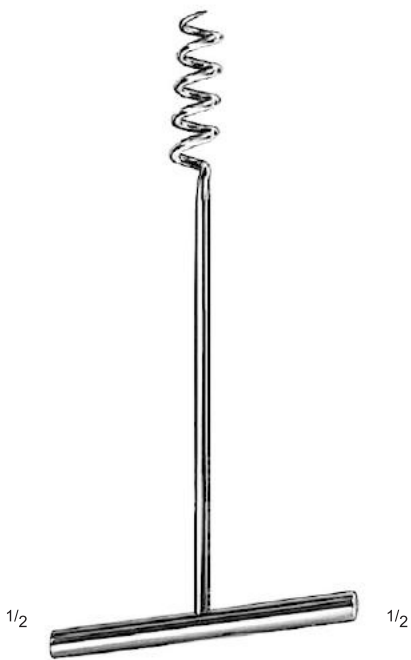

DOYEN
10-090-170
17 cm / 6 3/4"
ø 20 mm

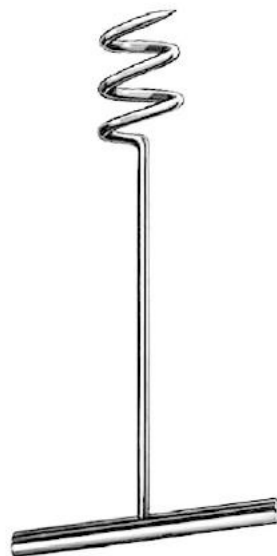

DOYEN
10-091-140
14 cm / 5 1/2"
ø 29 mm



NOVAK
10-092-230
23 cm / 9"

KOVOURKIAN-YOUNG
10-093-300
30 cm / 12"

Uterine Scoops



10-094-001
 # 1 - 7 mm



10-094-002
 # 2 - 8 mm



10-094-003
 # 3 - 10 mm

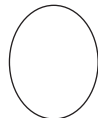

10-094-004
 # 4 - 11 mm



10-094-005
 # 5 - 12 mm

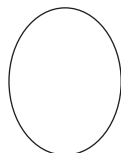

$\frac{1}{1}$
10-094-006
 # 6 - 15 mm



10-095-001
 #1 - 7 mm



10-095-002
 # 2 - 8 mm



10-095-003
 # 3 - 10 mm



10-095-004
 # 4 - 11 mm



10-095-005
 # 5 - 12 mm



$\frac{1}{1}$
10-096-006
 # 6 - 15 mm



$\frac{1}{2}$

SIMON
 29 cm / 11 $\frac{1}{2}$ "
 Rigid, Sharp



$\frac{1}{2}$

SCHROEDER
 30 cm / 12"
 Rigid, Sharp

Uterine Curettes

Sharp

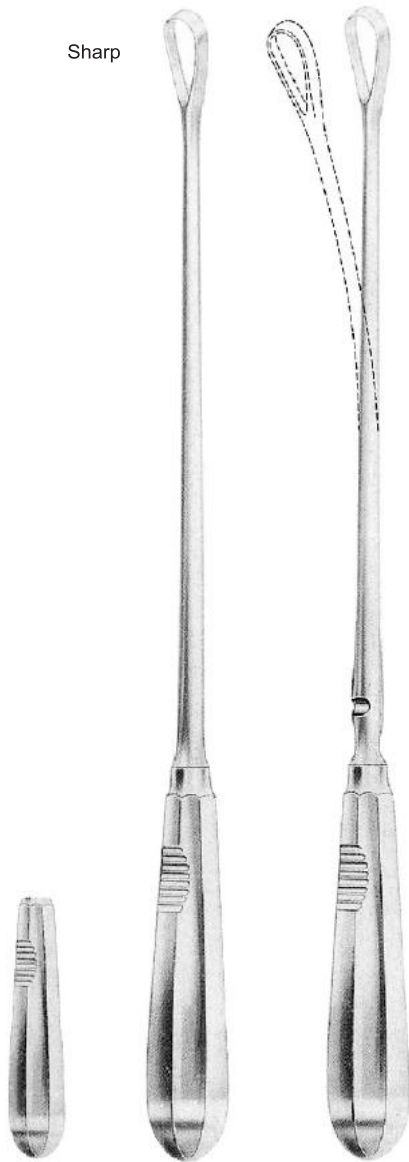

Sharp Curettes
(Recamier handles)

RECAMIER
14. 155.00 – 14. 161.60

Blunt



Rigid Curettes
(Plain Shaft)

Malleable Curettes
(Grooved Shaft)

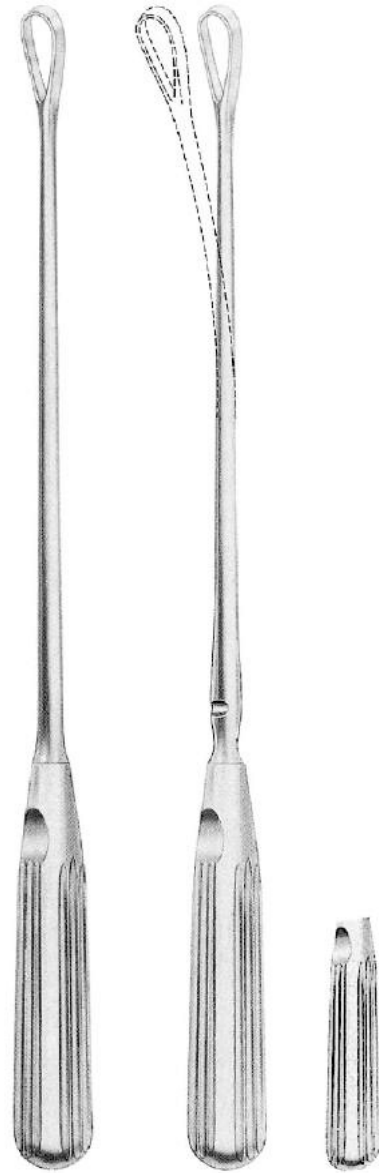

RECAMIER
14. 156.00 – 14. 163.60

Blunt Curettes
(Sims handles)

Rigid		Malleable
10-097-005	- Fig 00- 5 mm -	-
10-097-006	- Fig 0- 6 mm -	10-098-006
10-097-007	- Fig 1- 7 mm -	10-098-007
10-097-008	- Fig 2- 8 mm -	10-098-008
10-097-009	- Fig 3- 9 mm -	10-098-009
10-097-011	- Fig 4- 11 mm -	10-098-011
10-097-012	- Fig 5- 12 mm -	10-098-012
10-097-014	- Fig 6- 14 mm -	10-098-014
10-097-015	- Fig 7- 15 mm -	10-098-015
10-097-016	- Fig 8- 16 mm -	10-098-016
10-097-019	- Fig 9- 19 mm -	10-098-019
10-097-020	- Fig 14. 20 mm -	10-098-020
10-097-021	- Fig 15. 21 mm -	10-098-021
10-097-023	- Fig 21. 23 mm -	10-098-023
10-097-025	- Fig 13-25 mm -	10-098-025
10-097-030	- Fig 14-30 mm -	10-098-030
10-097-035	- Fig 15-35 mm -	10-098-035
10-097-040	- Fig 16-40 mm -	10-098-040

Rigid		Malleable
10-099-005	- Fig 00- 5 mm -	-
10-099-006	- Fig 0- 6 mm -	10-100-006
10-099-007	- Fig 1- 7 mm -	10-100-007
10-099-008	- Fig 2- 8 mm -	10-100-008
10-099-009	- Fig 3- 9 mm -	10-100-009
10-099-011	- Fig 4- 11 mm -	10-100-011
10-099-012	- Fig 5- 12 mm -	10-100-012
10-099-014	- Fig 6- 14 mm -	10-100-014
10-099-015	- Fig 7- 15 mm -	10-100-015
10-099-016	- Fig 8- 16 mm -	10-100-016
10-099-019	- Fig 9- 19 mm -	10-100-019
10-099-020	- Fig 14. 20 mm -	10-100-020
10-099-021	- Fig 15. 21 mm -	10-100-021
10-099-023	- Fig 21. 23 mm -	10-100-023
10-099-025	- Fig 13-25 mm -	10-100-025
10-099-030	- Fig 14-30 mm -	10-100-030
10-099-035	- Fig 15-35 mm -	10-100-035
10-099-040	- Fig 16-40 mm -	10-100-040

Uterine Curettes

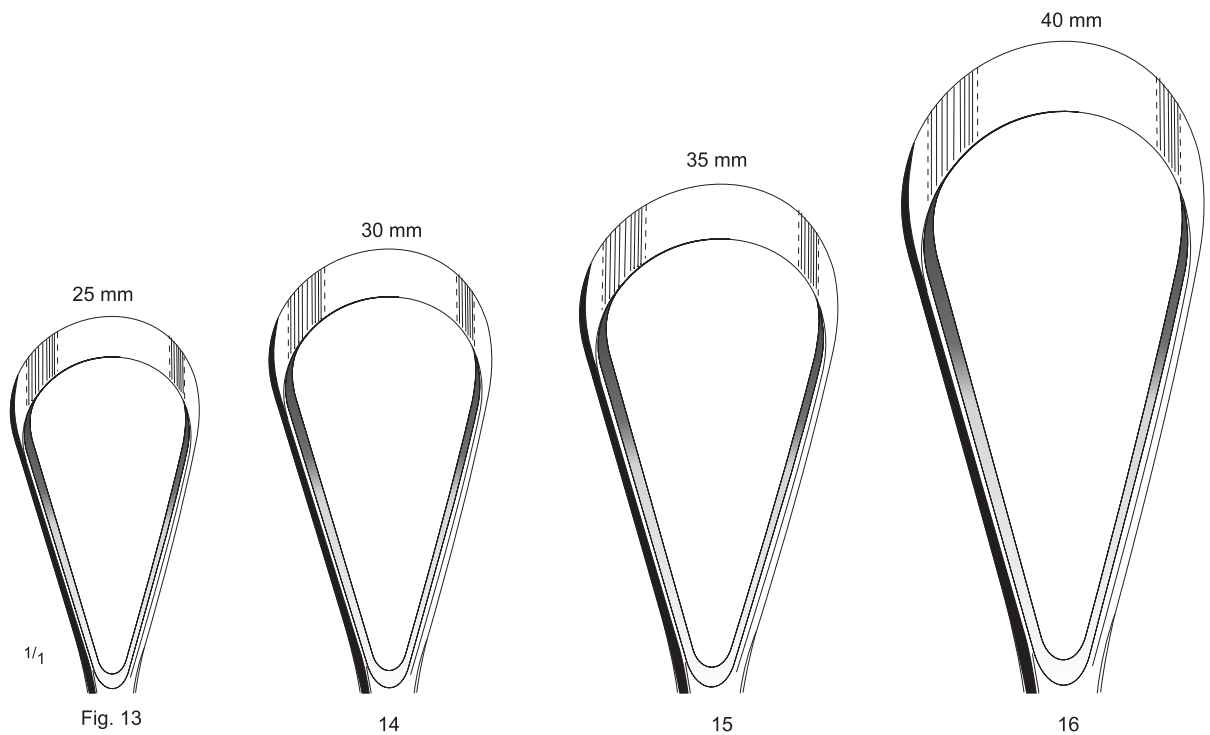
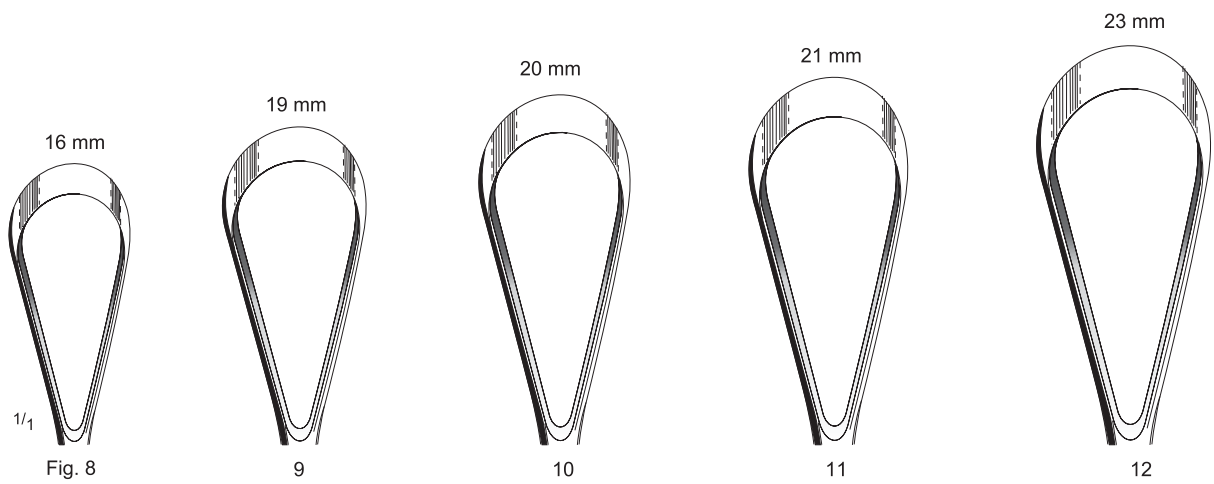
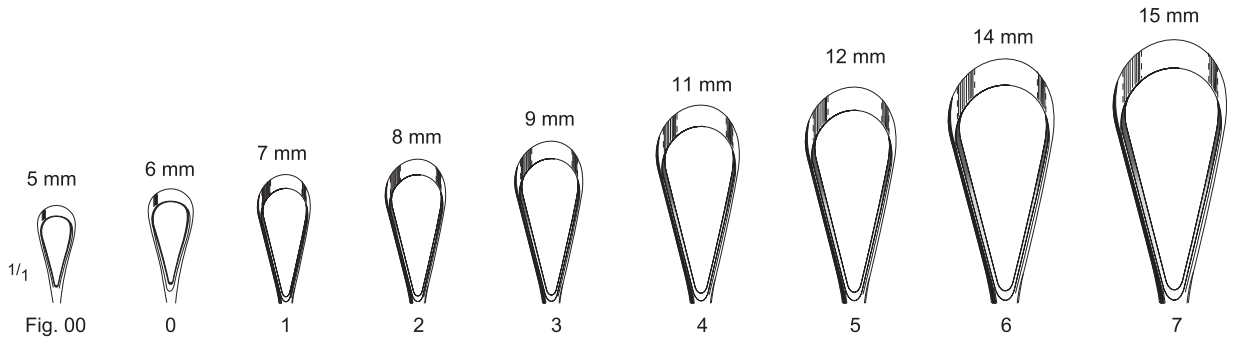

Pelvimetre, Amniotome, Scalp Flap Forceps, Obstetrical Forceps



1/4

MARTIN
10-101-340
 34 cm / 13 1/2"
 cm scale



1/3

BEACHAM
10-102-240
 24 cm / 9 1/2"

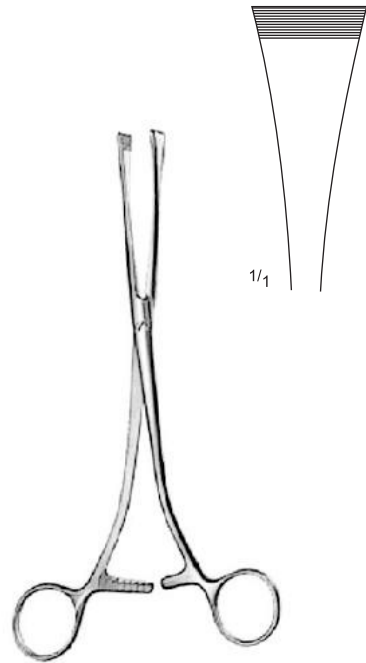

1/1

1/3

GREEN ARMYTAGE
10-103-220
 22 cm / 8 3/4"



1/4

DeLEE
10-104-360
 36 cm / 14 1/4"

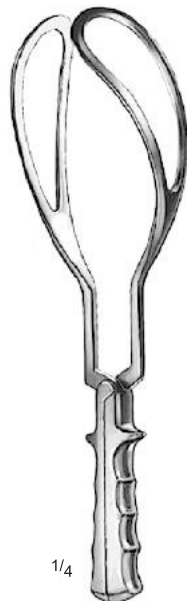

1/4

SIMPSON
10-105-320 – 32 cm / 12 1/2"
10-106-360 – 36 cm / 14 1/4"



1/4

KIELLAND
10-107-400
 40 cm / 15 3/4"

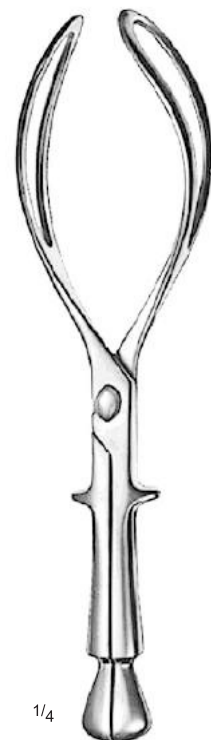

1/4

NAEGELE
10-108-360 – 36 cm / 14"
10-109-400 – 40 cm / 15 3/4"

Episiotomy Scissors, Umbilical Cord Scissors

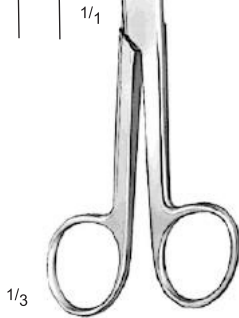
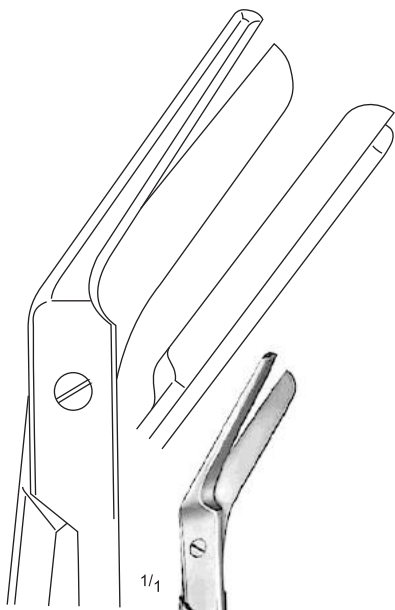

1/3

BRAUN STADLER
10-110-150
 15 cm / 6"

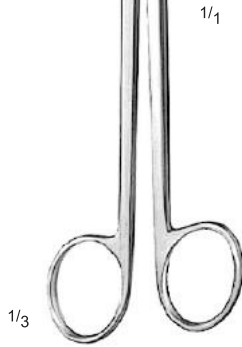
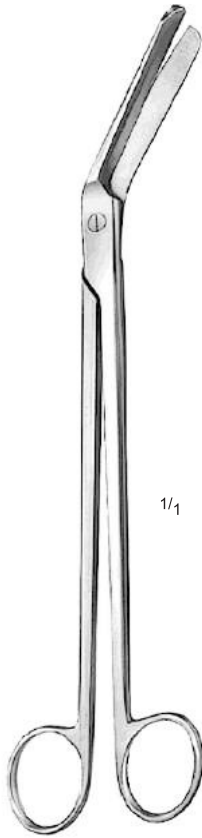

1/3

BRAUN STADLER
10-111-210
 21 cm / 8 1/4"

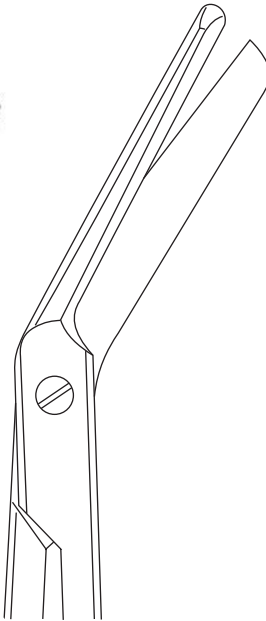

1/3

USA PATTERN
10-112-105
 10.5 cm / 4 1/4"

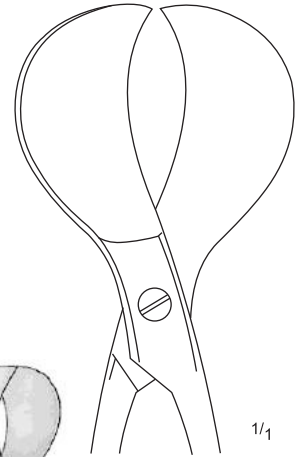

1/1

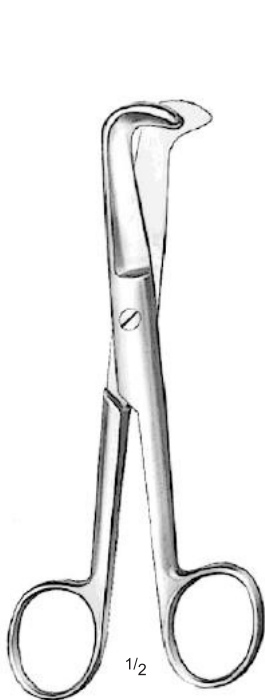

1/2

SCHUMACHER
10-113-160

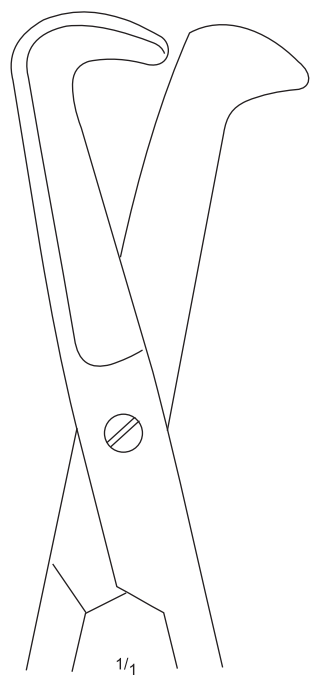

1/1

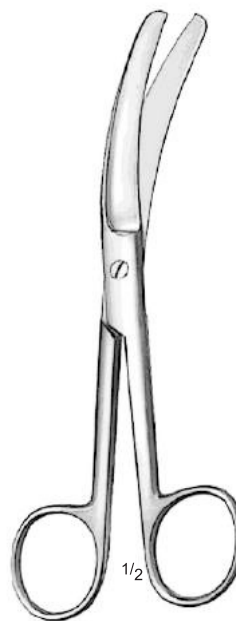

1/2

BUSCH
10-114-160

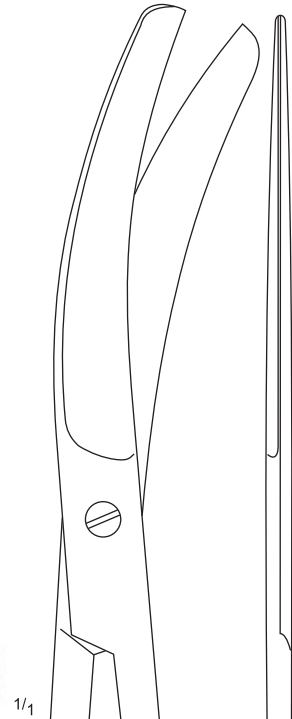

1/1

Elevating Spoon, Cord Clamps, Placenta Forceps



1/4

SELHEIM
 10-115-280
 28 cm / 11"

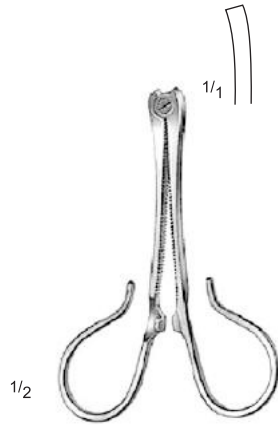

1/2

KANE
 10-116-085
 8.5 cm / 3 1/2"



1/2

COLLIN
 10-117-090
 9 cm / 3 1/2"

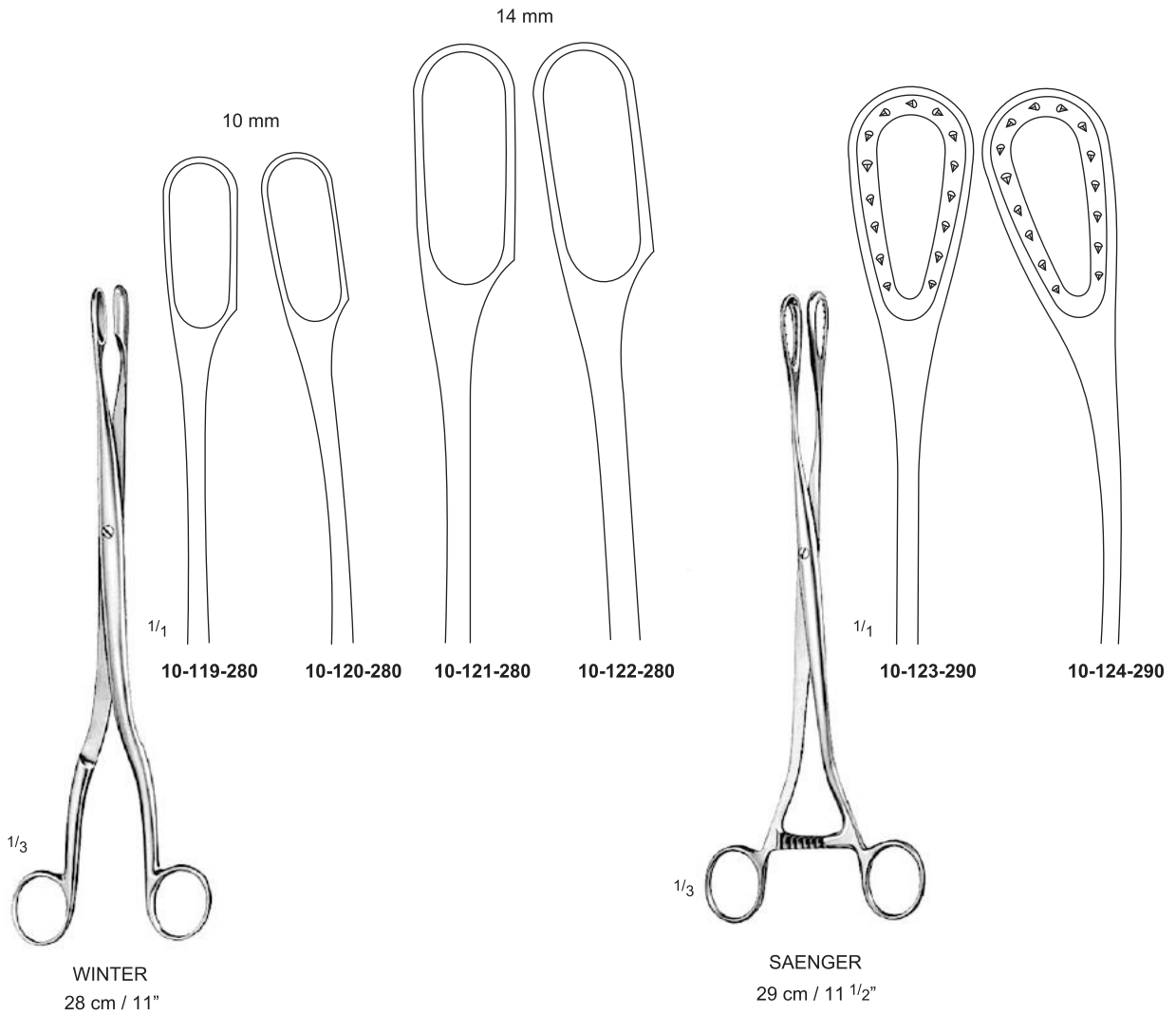

1/1

10-119-280

10-120-280

10-121-280

10-122-280

1/1

10-123-290

10-124-290

1/3

WINTER
 28 cm / 11"

1/3

SAENGER
 29 cm / 11 1/2"